

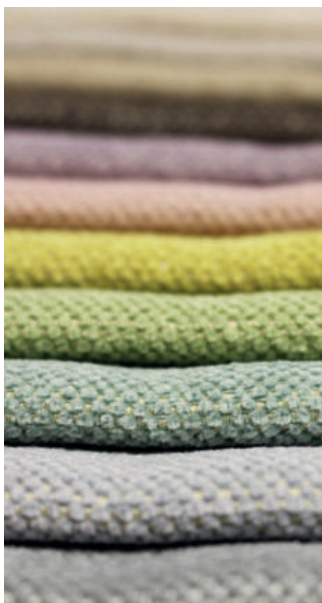

LUMCO[®]

ČESKÝ VÝROBCE
SEDACÍCH SOUPRAV



WWW.LUMCO.CZ



Jsme hrdými členy...



Garantováno...



Naše firma získala významné ocenění a to druhé místo v soutěži Vodafone Firma roku 2017 Královéhradeckého kraje



Ocenění nazvané Firma roku Náchodska 2016 zorganizovala Krajská hospodářská komora Královéhradeckého kraje, oblast Náchod. Druhým rokem byly oceněny významné regionální firmy.



Sedací soupravy,
pohovky a křesla.

Vrstvení sedací soupravy

1. kostra
2. filc
3. polyuretanová pěna
4. rouno z dutého vlákna
5. potahový materiál



Polstrovaný nábytek pro Váš domov

Vznik ryze české společnosti Lumco spol. s r.o. se sídlem v České Skalici se datuje k roku 2004. Na počátku se firma zabývala obchodní činností – nákupem a prodejem dřevěného i čalouněného nábytku. Od roku 2011 započala vlastní výrobu čalouněného nábytku a to především s širokou nabídkou systémových sedacích souprav.

„Neustále vyvíjíme nové modely s moderním designem, abychom uspokojili i toho nejnáročnějšího zákazníka se zájmem o kvalitní čalouněný nábytek. Naším hlavním mottem je profesionalita, neustálé zlepšování a zkvalitňování našich produktů. Návrhy pocházejí přímo od nás a tvoříme je spolu s designery. Snažíme se plnit přání našich zákazníků, což dokazuje vzrůstající prodejnost našich produktů v celé České republice.“

„Odbornost a zkušenosti nám umožňují navrhovat a vyrábět atypický nábytek určený do soukromých i veřejných prostor. Ve výrobě kombinujeme současné technologie s řemeslnými tradicemi, kde klademe velký důraz na precizní ruční práci. Používané výrobní materiály jsou ověřené, kvalitní od renomovaných evropských výrobců a zajišťují dlouhodobou životnost.“

V případě zájmu o některý výrobek z naší nabídky Vám rádi poradíme nebo můžete navštívit naše webové stránky www.lumco.cz.
Kontaktujte nás: odbyt@lumco.cz



Upholstered furniture for your home

Our strictly czech company Lumco Ltd. situated in Ceska Skalice has been established in 2004. At the beginning the company had been focused on trading such as selling and buying wooden and upholstered furniture. Since 2011 the company has started its own production of upholstered furniture with a wide range of sofas.

„We are designated to inventing new models with a modern design to accomodate even our most demanding customer interested in high quality upholstered furniture. Our main motto is professionalism, continuing improvement, and our product enhancing. Overtures are proposed directly by our team and are created along with designers. Our goal is to fulfill requests of our customers and growing sales of our product all over the Czech Republic is our proof.“

„Our experties and knowledge allow us to design and create unusual furniture for private and public sectors. We combine uptodate technologies with workmanlike customs pointing out the rigorous handwork. Material we use is certified quality by renowned European manufacturers and provide long-term service life.“

If you are interested in a product from our offer please don't hesitate and contact us or visit our websites www.lumco.cz.
Contact us: odbyt@lumco.cz



Gepolsterte Möbel für Ihr Heim

Die echt tschechische Gesellschaft Lumco GmbH. mit dem Sitz in der Stadt Česká Skalice entstand im Jahr 2004. Am Anfang beschäftigte sich die Firma mit dem Handel – mit dem Einkauf und mit dem Verkauf von Holzmöbel und gepolsterten Möbel. Seit 2011 begann sie mit der eigenen Produktion der gepolsterten Möbel, vor allem mit dem breiten Angebot von Systemsitzgarnituren.

„Wir entwickeln immer neue Modelle mit modernem Design, um auch die anspruchsvollen Kunden mit Interesse an Qualitätsmöbel zu befriedigen. Unser Hauptmotto ist Profesionalität, ständige Qualitätsverbesserung von unseren Produkten. Die Vorschläge kommen direkt von uns und wir bilden sie zusammen mit Designern. Wir bemühen uns, alle Wünsche von unseren Kunden zu erfüllen. Das beweist aufwachsende Verkaufbarkeit unserer Produkte in der ganzen Tschechischen Republik.“

„Die Fachkenntnis und Erfahrungen ermöglichen uns, atypische Möbel für private und öffentliche Räume vorzuschlagen und herzustellen. In der Produktion kombinieren wir gegenwertige Technologien mit Handwerkstraditionen, in denen wir den Nachdruck auf die Präzisionshandarbeit legen. Die verwendeten Produktionsmaterialien sind überprüft, hochwertig von renommierten, europäischen Herstellern und sie versichern langfristige Lebensdauer.“

Im Fall, dass Sie sich für ein Produkt aus unserem Angebot interessieren, beraten wir Ihnen gern oder Sie können unsere Webseiten www.lumco.cz besuchen.

Kontaktieren Sie uns: odbyt@lumco.cz



Les meubles rembourrés pour votre maison

La création de la société tchèque Lumco spol. s.r.o. basée à Česká Skalice remonte à 2004. Au début, la société a été engagée dans les affaires – l'achat et la vente des meubles en bois et rembourrés. Depuis 2011, elle a commencé sa propre production de meubles rembourrés et surtout avec une large gamme de canapés.

„Nous développons constamment de nouveaux modèles avec un design moderne pour satisfaire les clients les plus exigeants et intéressés par des meubles de qualité rembourrés. Notre devise principale est le professionnalisme, l'amélioration continue et l'amélioration de nos produits. Les propositions viennent directement de chez nous et nous les créons avec les designers. Nous essayons de répondre aux souhaits de nos clients, comme en témoigne la commercialisation croissante de nos produits en République tchèque.“

„La spécialité et l'expérience nous permettent de concevoir et de produire des meubles atypiques conçus pour des espaces privés et publics. Dans la production, nous combinons la technologie contemporaine avec les traditions d'artisanat, où nous mettons l'accent sur le travail manuel précis. Les matériaux de production utilisés sont prouvés et de qualité provenant de fabricants européens renommés et assurent une longue vie.“

Si vous êtes intéressé par un produit de notre offre, nous serons heureux de vous conseiller ou veuillez se rendre sur notre site www.lumco.cz.
Contactez-nous: odbyt@lumco.cz



8 Karin



10 Ester



12 Natali



14 Klára



26 Kryštof



26 Bigi



26 Simon



26 Janett



16 Olivie



18 Leona



20 Adel



21 Klaudie



27 Lukas



27 Tigra



28 Mia



28 Mia II.



22 Jerry



22 Filip



23 Dream



24 Lada



28 Viki



29 Taburetky



30 Ostatní



31 Ostatní



24 Područka USB



25 Daniela



25 Ondra



31 KLAP matrace

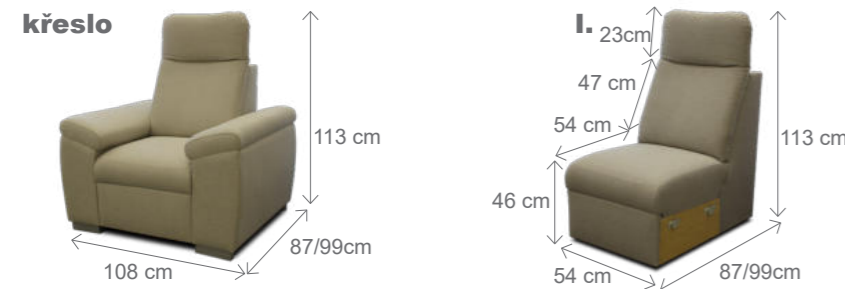

KARIN



Všechny sedací soupravy jsou určeny na nosnost 110 kg, po domluvě lze použít PUR výplně sedáků na vyšší zátěž.

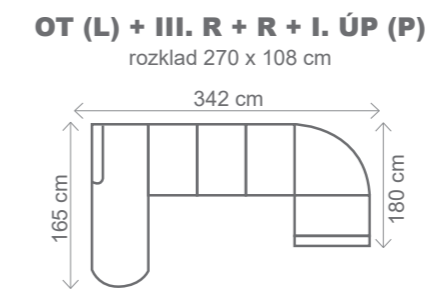
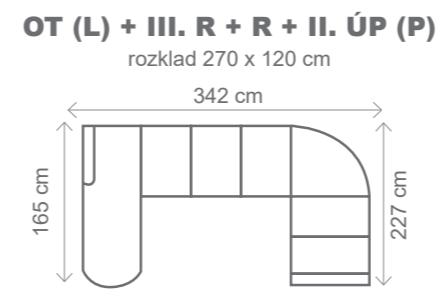
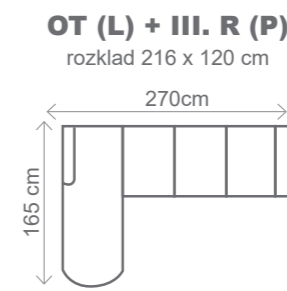
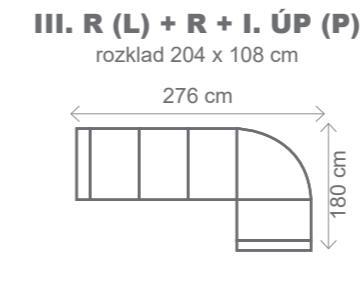
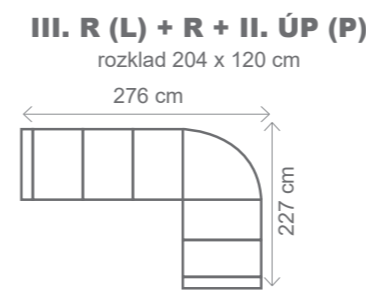

Každá sestava z technologických důvodů musí být zakončena područkou. Ve specifických případech kontaktujte výrobce.

Rozměry se mohou měnit v závislosti na poloze/sklopení záhlavníku. Relaxační polohovatelné záhlavníky mají 6 volitelných poloh. Sedací souprava Karin je rozkládací včetně úložného prostoru. Možnost odmontování záhlavníků kvůli stěhování (u R a I). Nabízíme výběr ze dvou druhů područek: A (standard) a B (rovné) jako u sedací soupravy Kláry. Sedací souprava má očalouněná záda v barvě potahu, díky tomu můžete sedačku umístit do volného prostoru, možnost levého a pravého provedení.

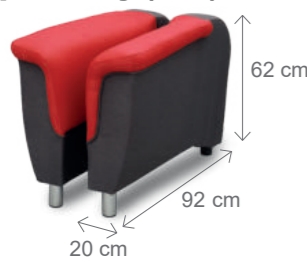
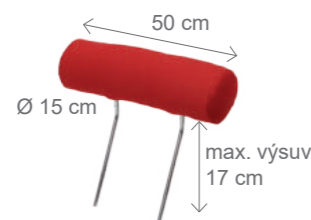
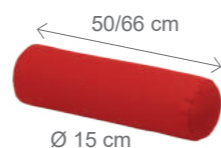

křeslo**I.****II. (L+P)****II.****II. ÚP****III. (L+P)****III.****III. ÚP****III. R****OT I****OT II****R - polohovací****područky (L+P)****podhlavník ESTER****univerzální podhlavník****válec**

Každá sestava z technologických důvodů musí být zakončena područkou.
Ve specifických případech kontaktujte výrobce.

ESTER



Všechny sedací soupravy jsou určeny na nosnost 110 kg, po domluvě lze použít PUR výplně sedáků na vyšší zátěž.

OT I (L) + III. R + R + II. ÚP (P)
rozklad 284 x 122 cm

III. R (L) + OT2 (P)
rozklad 205 x 122 cm

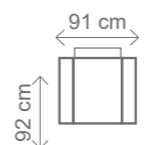
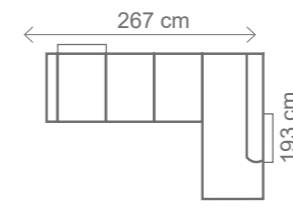
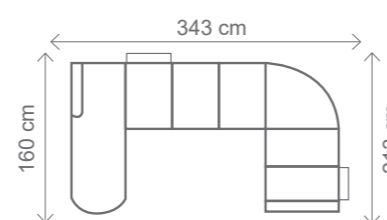
KŘESLO

III. R (L) + R + II. ÚP (P)
rozklad 202 x 122 cm

OT I (L) + III. R (P)
rozklad 230 x 122 cm

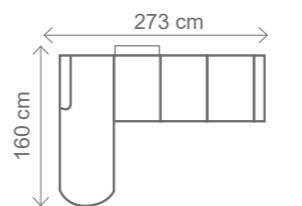
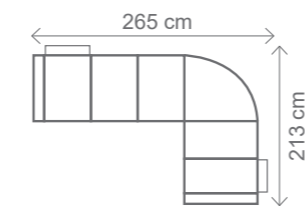

NATALI

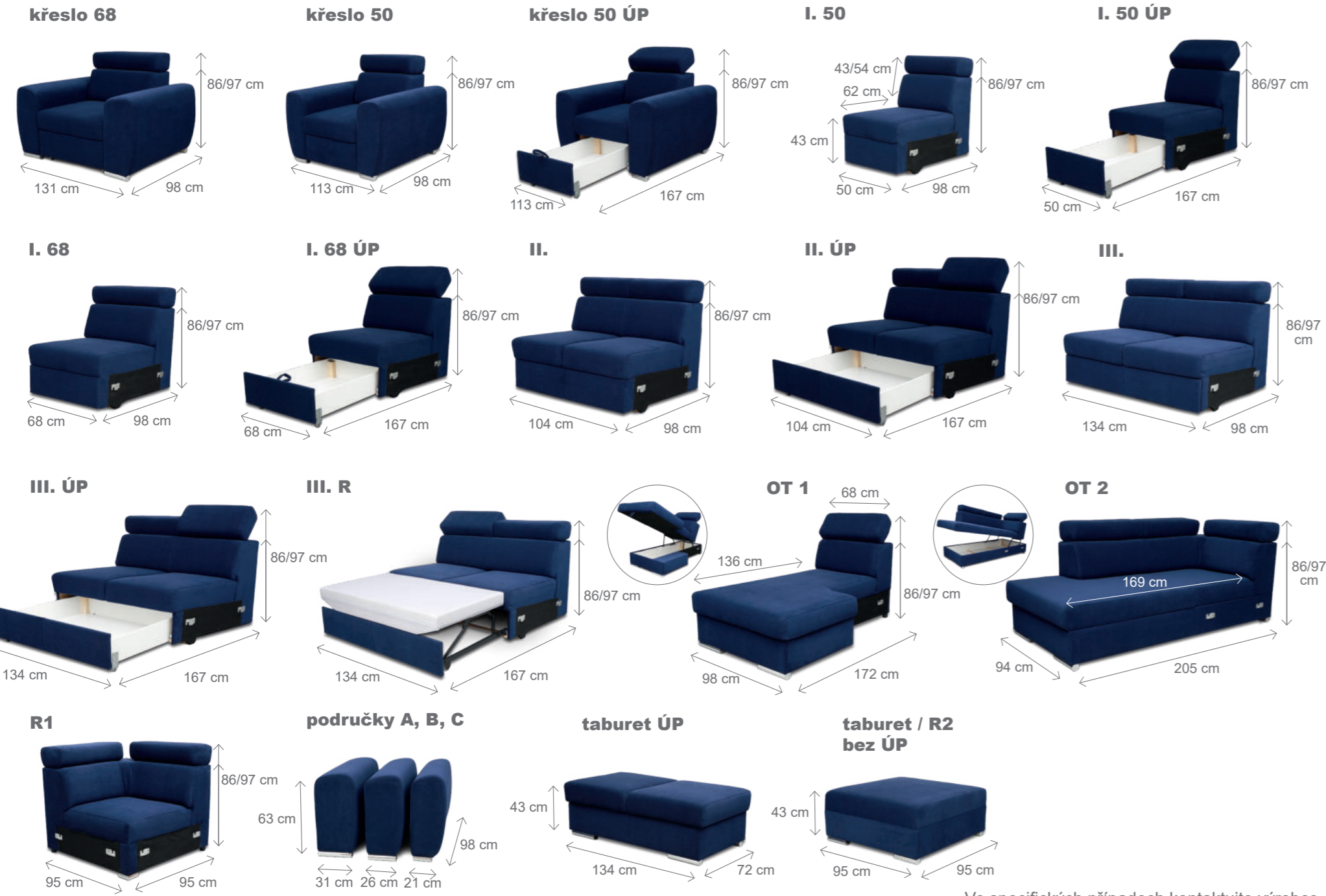

Všechny sedací soupravy jsou určeny na nosnost 130 kg, po domluvě lze použít PUR výplně sedáků na vyšší zátěž.

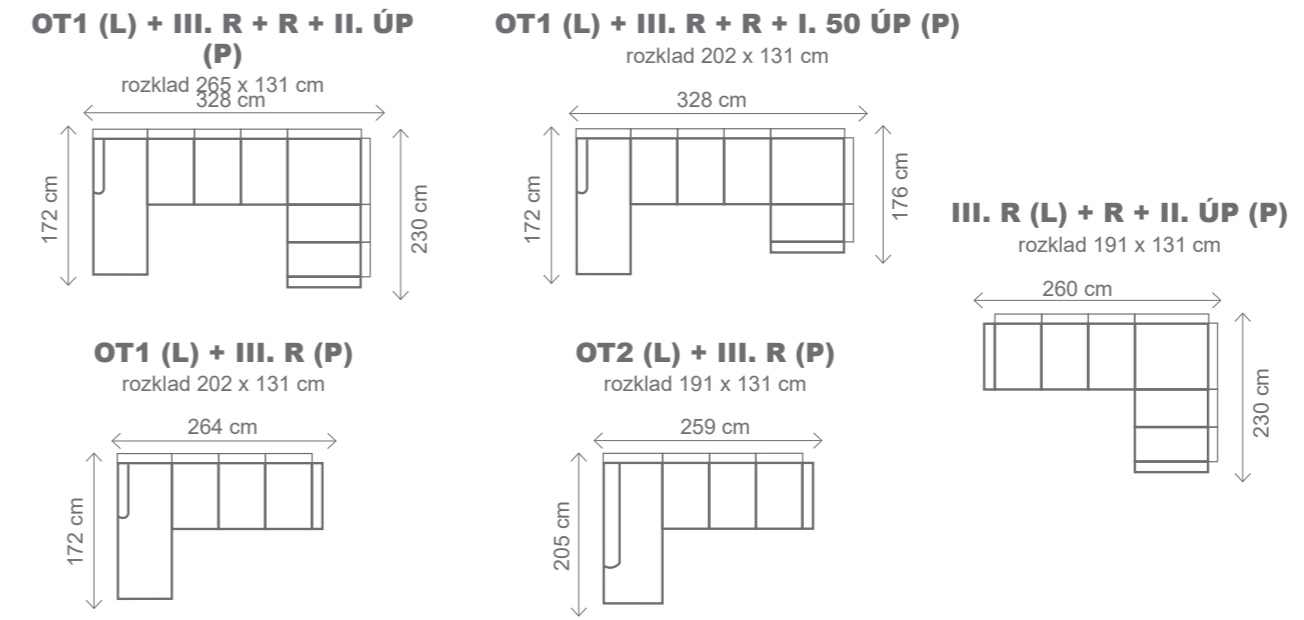

Rozměry se standardními područkami (A).



Ve specifických případech kontaktujte výrobce. Každá sestava z technologických důvodů musí být zakončena područkou.

křeslo



I.



I. ÚP



II. (L+P)



II.



KLÁRA

II. ÚP (L+P)



II. ÚP



III. (L+P)



III.



III. ÚP (L+P)



područky A (standard)



Všechny sedací soupravy jsou určeny na nosnost 110 kg, po domluvě lze použít PUR výplně sedáků na vyšší zátěž.

III. ÚP



III. R



III. SOFA



OT



OT (L) + III. R + R + II. ÚP (P)

rozklad 270 x 120 cm

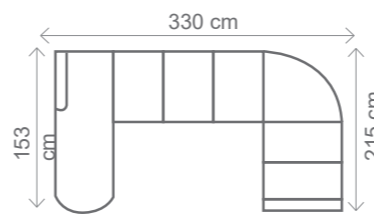

OT (L) + III. R + R + I. ÚP (P)

rozklad 270 x 108 cm

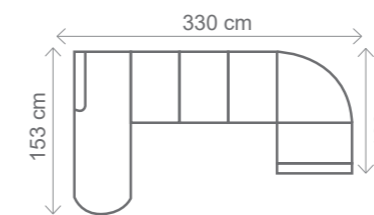

OT (L) + III. R (P)

rozklad 216 x 120 cm

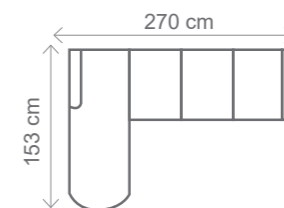

III. R (L) + R + II. ÚP (P)

rozklad 204 x 120 cm

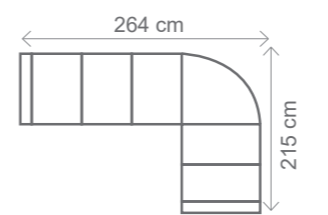

III. R (L) + R + I. ÚP (P)

rozklad 204 x 108 cm

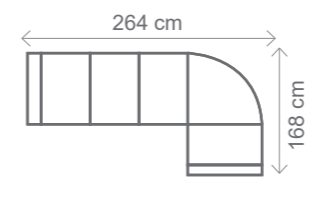

područky B (rovné)



područky A (standard)

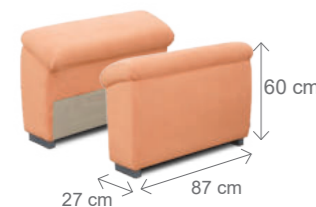

područky B (rovné)

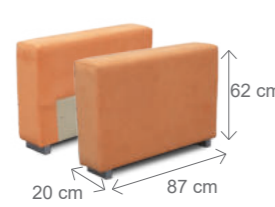

područka USB

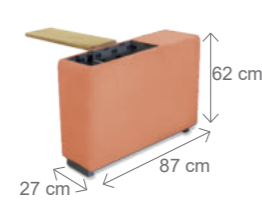

taburetku KLÁRA ÚP

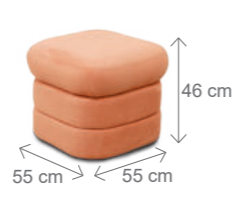

taburetku KLÁRA zakončovací bez ÚP



R



Rozměry se standardními područkami (A).



Ve specifických případech kontaktujte výrobce. Každá sestava z technologických důvodů musí být zakončena područkou.

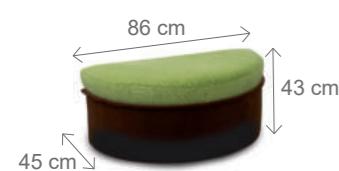
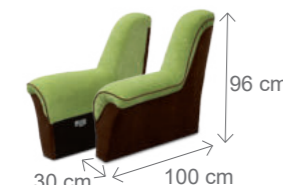

křeslo**I. 55****I. 55 ÚP****I. 70****I. 70 ÚP****II.****II. ÚP****II. R****III. R****III. ÚP****OT****III.****R****R I.****R IV.****taburetka půlkruh bez ÚP****područky (L+P)****taburetka OLIVIE bez ÚP****podhlavník Olivie**

OLIVIE

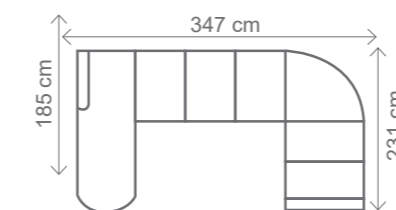
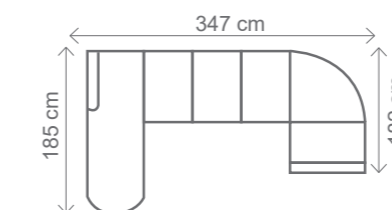
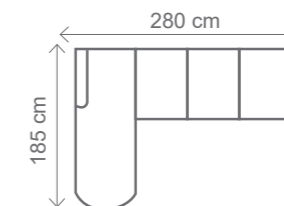
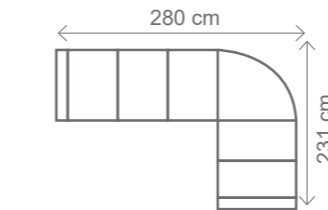
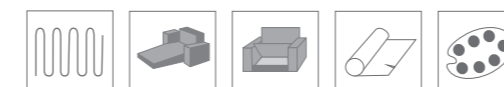
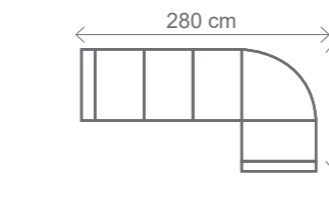

Všechny sedací soupravy jsou určeny na nosnost 110 kg, po domluvě lze použít PUR výplně sedáků na vyšší zátěž.

OT (L) + III. R + R + II. ÚP (P)
rozklad 270 x 123 cm**OT (L) + III. R + R + I. 55 ÚP (P)**
rozklad 270 x 113 cm**OT (L) + III. R (P)**
rozklad 215 x 123 cm**III. R (L) + R + II. ÚP (P)**
rozklad 205 x 123 cm**III. R (L) + R + I. 55 ÚP (P)**
rozklad 205 x 113 cm

křeslo



I. 55



I. 55 ÚP



I. 70



I. 70 ÚP



II.



II. ÚP



II. R



III.



III. ÚP



OT



III. R



R



R I.

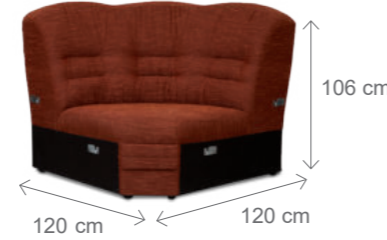

područky (L+P)



taburetka MONA ÚP

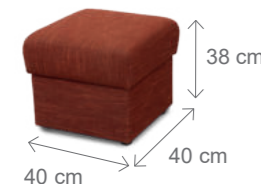

LEONA



Všechny sedací soupravy jsou určeny na nosnost 110 kg, po domluvě lze použít PUR výplně sedáků na vyšší zátěž.

OT (L) + III. R + R + II. ÚP (P)
rozklad 260 x 118 cm

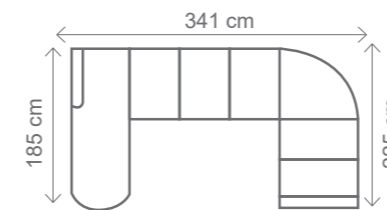

OT (L) + III. R + R + I. 55 ÚP (P)
rozklad 260 x 100 cm

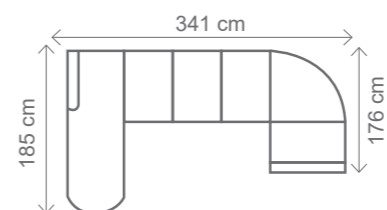

OT (L) + III. R (P)
rozklad 206 x 118 cm

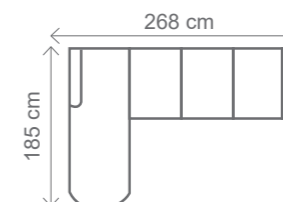

III. R (L) + R + II. ÚP (P)
rozklad 196 x 118 cm

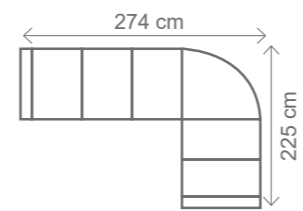

III. R (L) + R + I. 55 ÚP (P)
rozklad 196 x 100 cm

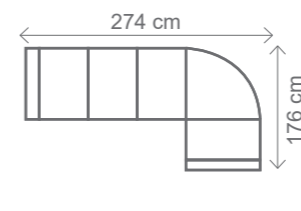

ADEL

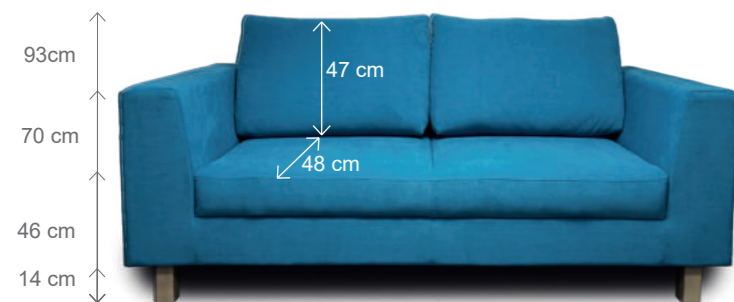

Všechny sedací soupravy jsou určeny na nosnost 110 kg, po domluvě lze použít PUR výplně sedáků na vyšší zátěž.

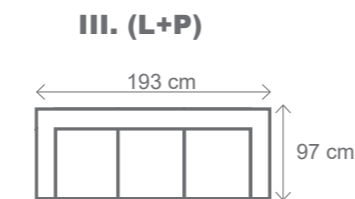
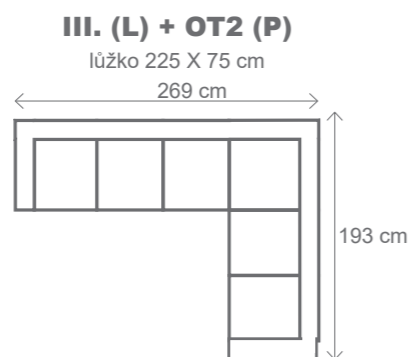
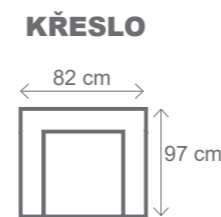
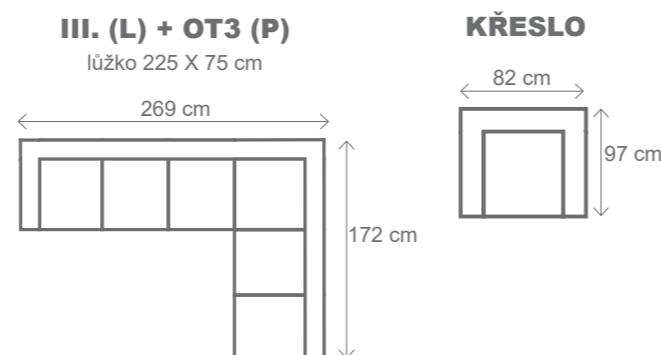
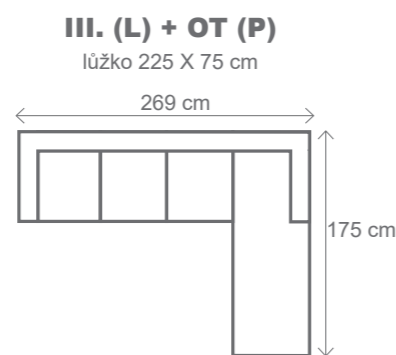

Všechny sedací soupravy jsou určeny na nosnost 110 kg, po domluvě lze použít PUR výplně sedáků na vyšší zátěž. Každá sestava z technologických důvodů musí být zakončena područkou.

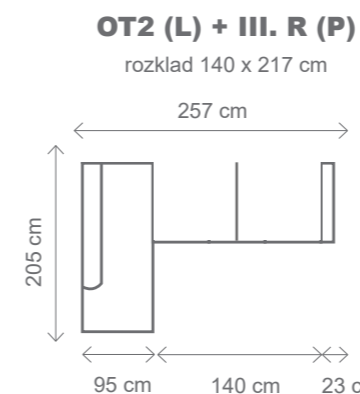

Otoman není úložný.

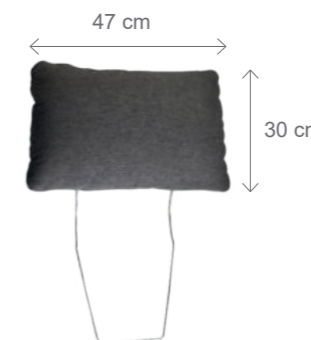

ROZMĚRY (cm)

výška	délka	hloubka	rozklad	v. sedu	hl. sedu	v. opěry od sedu
80	257	205	140 x 217	41	60	43



JERRY



ROZMĚRY (cm)

výška	délka	hloubka	rozklad	výška sedu	hloubka sedu	výška opěry od sedu
85	166	84	118 x 185	43	58	52

Všechny sedací soupravy jsou určeny na nosnost 110 kg, po domluvě lze použít PUR výplně sedáků na vyšší zátěž.



FILIP



ROZMĚRY (cm)

výška	délka	hloubka	rozklad	výška sedu	hloubka sedu	výška opěry od sedu
91	265	172	202 x 131	43	62	50

Všechny sedací soupravy jsou určeny na nosnost 110 kg, po domluvě lze použít PUR výplně sedáků na vyšší zátěž.



Pohovka pro každodenní spaní.



podhlavník



Všechny sedací soupravy jsou určeny na nosnost 110 kg, po domluvě lze použít PUR výplně sedáků na vyšší zátěž.

III. SOFA (L+P)

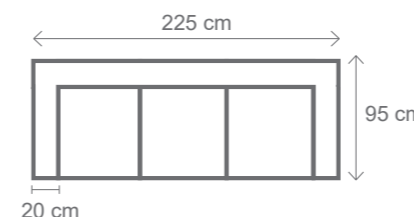

Rozměry soupravy pro šíři područek 20 cm.

OT (L) + III. SOFA (P)

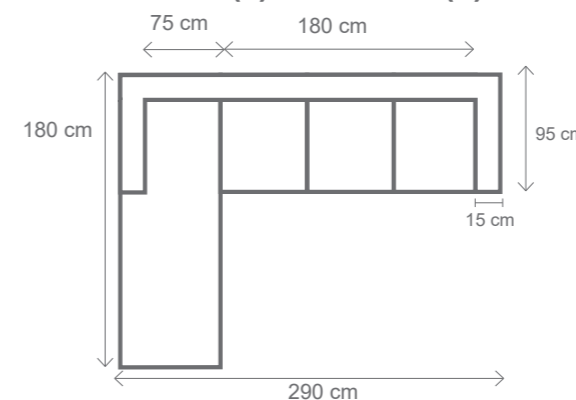

Možnost područek o šířce 10 cm, 15 cm, 20 cm.

ROZMĚRY (cm)

výška	délka	hloubka	výška od země k lůžku	lůžko	výška sedu	hloubka sedu	výška opěry od sedu
105	290	95	56	187x160x14	48,5	47	53



USB područka



DREAM

LADA



ROZMĚRY (cm)

výška	délka	hloubka	rozklad	výška sedu	hloubka sedu	výška opěry od sedu
100	258	160	215 x 130	46	55/71	58

Všechny sedací soupravy jsou určeny na nosnost 110 kg, po domluvě lze použít PUR výplně sedáků na vyšší zátěž.

Pohovka pro každodenní spaní.



Pohovky pro každodenní spaní.



ROZMĚRY (cm)

výška	délka	hloubka	rozklad	výška sedu	hloubka sedu	výška opěry od sedu
84	207	103	200 x 160	44	53/83	38/52

Všechny sedací soupravy jsou určeny na nosnost 110 kg, po domluvě lze použít PUR výplně sedáků na vyšší zátěž.

DANIELA



PODRUČKA USB

Područka s úložným prostorem, stolkem, USB a zá:

Možnost použití u sedacích souprav:
KARIN
KLÁRA
DREAM

Výchozí revizní zpráva dle vyhlášky č. 50 je součástí výroby.
Možnost moření výsuvného stolku.

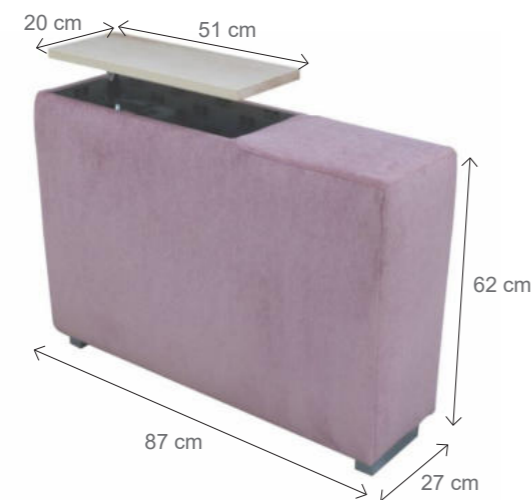

ONDRA



ROZMĚRY (cm)

výška	délka	hloubka	rozklad	výška sedu	hloubka sedu	výška opěry od sedu
84	200	100	200 x 160	44	50/80	38/52

Všechny sedací soupravy jsou určeny na nosnost 110 kg, po domluvě lze použít PUR výplně sedáků na vyšší zátěž.



ROZMĚRY (cm) NOHY (14 cm)

	Výš.	Dél.	Hl.	Výš. sedu	Hl. sedu	Výš. opěry
Lukas I (s bederním prošitím)	108	86	85	47	52	67
Lukas II	108	86	85	47	52	67
Lukas III	118	86	85	47	52	77
Lukas IV (s bederním prošitím)	118	86	85	47	52	77

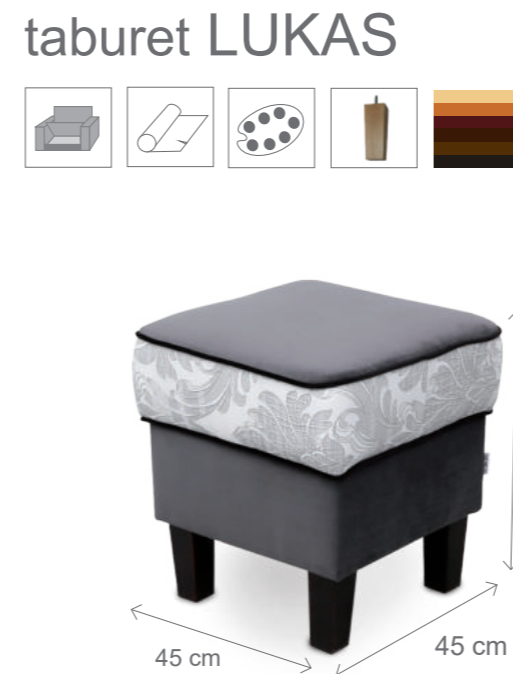
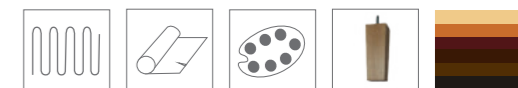

křesílko MIA

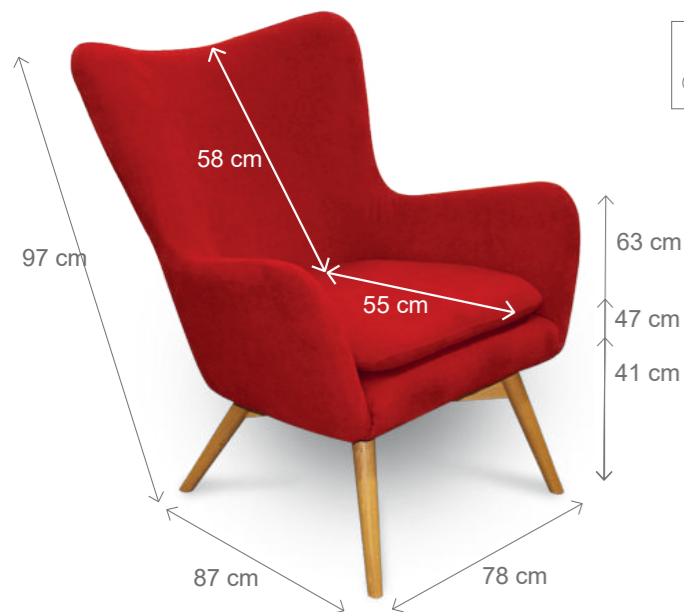
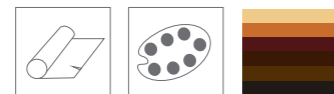

taburet MIA



křesílko MIA II.

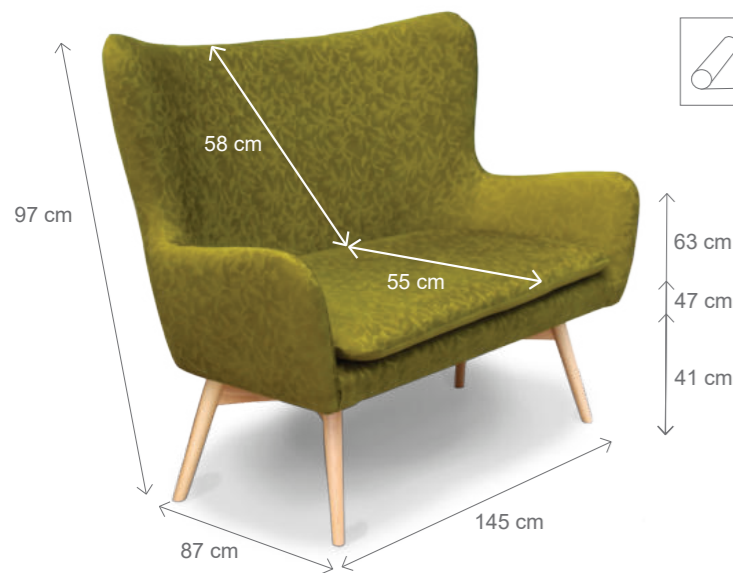

VIKI



OLIVIE



KLÁRA

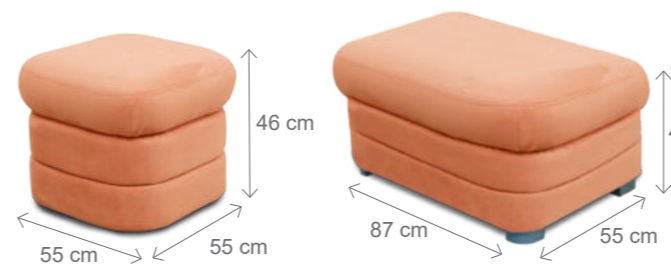

taburetko KLÁRA zakončovací bez ÚP

taburetky ADRIANA

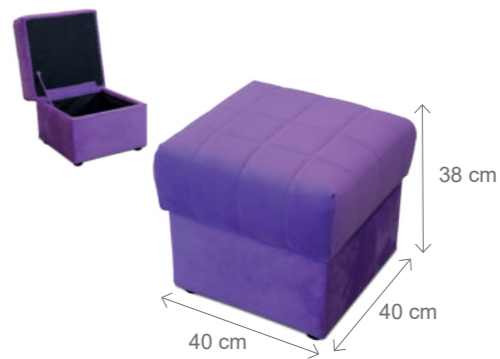

KARIN



taburetko KARIN zakončovací bez ÚP

NATALI

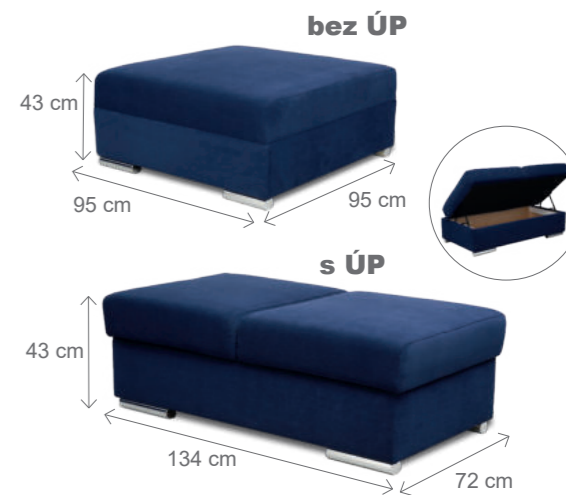

taburet 80 x 50

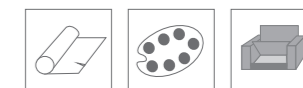
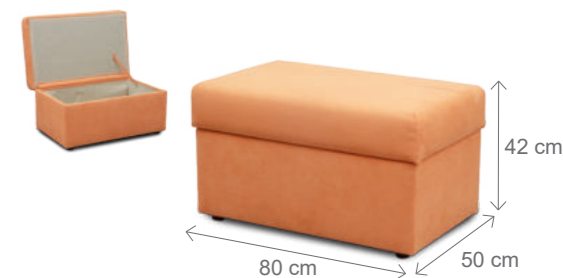

taburet 60 x 60

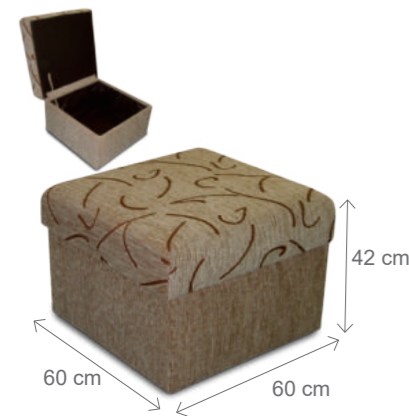

VIKI



MONA



PUK



sedací KOSTIČKA

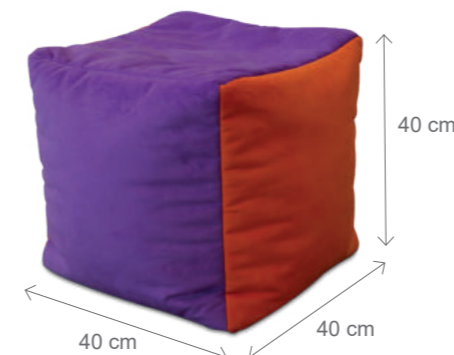

KLAP matrace



ROZMĚRY (cm)

	výška	délka	hloubka
rozložená/matrace	9	190	70
složená/taburet	28	63	70

polštář NELA

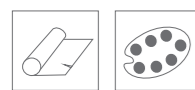
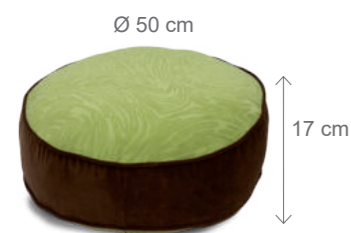

polštáře



LUMÍK

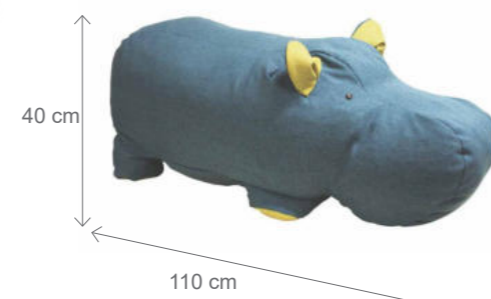

univerzální podhlavník



sedací VAK KLOKAN



ROZMĚRY (cm)

výška	délka	hloubka	objem	nosnost
86/105	86	70	200 l	120 kg

podložka pro mazlíčky



ROZMĚRY (cm)

A	B
77x97	58x58



Barevný vzorník dřeva



Buk



Olše



Mahagon



**Rusti-
kal**



Ořech



Wenge

Barvy jsou přibližné - mírná barevná odlišnost je

VYSVĚTLIVKY



křeslo

- I. 1-sed bez funkce
- I. ÚP 1-sed s úložným prostorem
- II. 2-sed bez funkce
- II. (L+P) 2-sed bez funkce s levou + pravou područkou
- II. ÚP 2-sed s úložným prostorem
- II. ÚP (L+P) 2-sed s úložným prostorem s levou + pravou područkou
- II. R 2-sed s rozkladem
- II. SOFA 2-sed s lehátkem
- III. 3-sed bez funkce
- III. (L+P) 3-sed bez funkce s levou + pravou područkou
- III. ÚP 3-sed s úložným prostorem
- III. ÚP (L+P) 3-sed s úložným prostorem s levou + pravou područkou
- III. R 3-sed s rozkladem
- III. SOFA 3-sed s lehátkem
- OT oتمان
- R roh



vlnitá pružina



bonel pružina



rozklad



úložný prostor



látka



barevná škála



chromovaná nožička



dřevěná nožička



buk



olše



mahagon



rustikal



ořech



wenge



armchair

- 1-place without function
- 1-place with storage space
- 2-places without function
- 2-places without function with left and right armrest
- 2-places with storage space
- 2-places with storage space with left and right armrest
- 2-places with function of enlargement
- 2-places with folding bed
- 3-places without function
- 3-places without function with left and right armrest
- 3-places with storage space
- 3-places with storage space with left and right armrest
- 3-places with function of enlargement
- 3-places with folding bed
- divan
- corner

corrugated spring

bonnell spring

function of enlargement

storage space

textile fabric

color range

chromium foot

wooden foot

beech

alder

mahogany

rustical

walnut

wenge



Sessel

- 1-er Sofa ohne Funktion
- 1-er Sofa mit dem Laderaum
- 2-er Sofa ohne Funktion
- 2-er Sofa ohne Funktion mit der linken und rechten Armlehne
- 2-er Sofa mit dem Laderaum
- 2-er Sofa mit dem Laderaum mit der linken und rechten Armlehne
- 2-er Sofa mit der Zerlegung
- 2-er Sofa mit der Liege
- 3-er Sofa ohne Funktion
- 3-er Sofa ohne Funktion mit der linken und rechten Armlehne
- 3-er Sofa mit dem Laderaum
- 3-er Sofa mit dem Laderaum mit der linken und rechten Armlehne
- 3-er Sofa mit der Zerlegung
- 3-er Sofa mit der Liege
- Ottomane
- Ecke

wellige Feder

bonel Feder

Zerlegung

Laderaum

Stoff

Auswahl an den Farben

das Chrombeinchen

das Holzbeinchen

büchen

erle

mahagoni

rustikal

nussbraun

wenge



fauteuil

- monoplace sans fonction
- monoplace à espace de stockage
- à siège double sans fonction
- à siège double sans fonction à accouoir gauche + droit
- à siège double à espace de stockage
- à siège double à espace de stockage à accouoir gauche + droit
- à siège double à décomposition
- à siege double à chaise longue
- à siege triple sans fonction
- à siege triple sans fonction à accouoir gauche + droit
- à siege triple à espace de stockage
- à siege triple à espace de stockage à accouoir gauche + droit
- à siege triple à décomposition
- à siege triple à chaise longue
- divan
- coin

ressort onduleux

ressort bonel

décomposition

espace de stockage

étouffe

gamme de couleurs

pied chromique

pied de bois

hêtre

aulne

acajou

rustique

noyer

wenge

Tolerance rozměru: ±3%. Výrobce si vyhrazuje právo konstrukčních změn u nabízených modelů nábytku beze změny jejich obecného charakteru. Obrázky jsou ilustrační a mohou se od reálných barevně lišit. Za tiskové chyby neručíme.

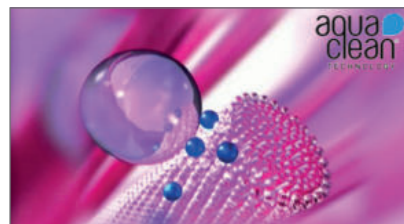
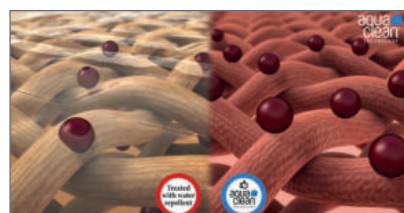

Öko-Tex Standard 100 je mezinárodní testovací a certifikační systém pro textilie, vyráběné pouze ze zdravotně nezávadných materiálů. Byl vyvinut v roce 1992.

Užívejte si více života ... protože AQUACLEAN myslí na vás. Díky inovativní technologii si můžete užívat života a nedělat si starosti s případnými skvrnami, které se mohou den co den objevit na vaší pohovce.

Aquaclean je pokročilá ochrana vaší čalouněné sedačky. Tato úprava pokrývá jednotlivá vlákna neviditelnou molekulární vrstvou, která zabrání proniknutí nečistot do látky.

www.aquaclean.com

Technologie Aquaclean je revoluční povrchová úprava, která umožňuje odstranit skvrny pouze pomocí vody. Údržba je velmi jednoduchá a skvrny odstraní za minimum času.

Aquaclean umožňuje snadné odstranění většiny skvrn vzniklých v domácnosti (víno, inkoust, omáčky, tuk, bláto, čokoláda, krém aj), usnadní vám tak život a vy získáte více času na důležité věci.



LUMCO spol. s r.o.

Maloskalická 68
Česká Skalice
552 03

Česká republika

Tel.: +420 491 420 473
Fax: +420 491 421 841

E-mail: odbyt@lumco.cz

www.lumco.cz